

NPN D 系列晶体管/ D SERIES TRANSISTORS

MJE13005H

- 特点: 耐压高 开关速度快 安全工作区宽 符合 RoHS 规范
- FEATURES: ■HIGH VOLTAGE CAPABILITY ■HIGH SPEED SWITCHING ■WIDE SOA ■RoHS COMPLIANT
- 应用: 节能灯 电子镇流器 电子变压器 开关电源
- APPLICATION: ■FLUORESCENT LAMP ■ELECTRONIC BALLAST ■ELECTRONIC TRANSFORMER
■SWITCH MODE POWER SUPPLY

- 最大额定值 (Tc=25°C)
- Absolute Maximum Ratings (Tc=25°C) TO-220/220FP

参数 PARAMETER	符号 SYMBOL	额定值 VALUE	单位 UNIT
集电极-基极电压 Collector-Base Voltage	V _{CBO}	800	V
集电极-发射极电压 Collector-Emitter Voltage	V _{CEO}	450	V
发射极-基极电压 Emitter-Base Voltage	V _{EBO}	9	V
集电极电流 Collector Current	I _C	4	A
集电极耗散功率 Total Power Dissipation	P _{tot}	65	W
最高工作温度 Junction Temperature	T _j	150	°C
贮存温度 Storage Temperature	T _{stg}	-65-150	°C

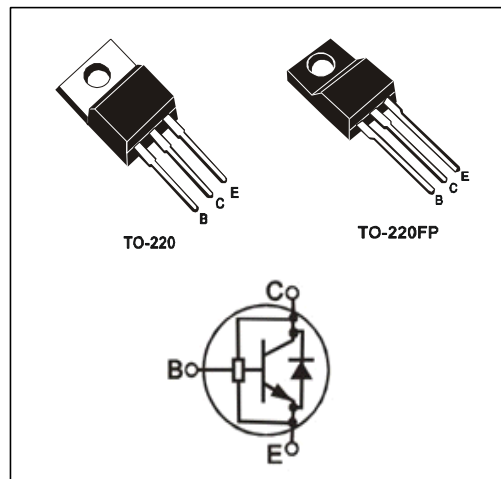

- 电特性 (Tc=25°C)
- Electronic Characteristics (Tc=25°C)

参数名称 CHARACTERISTICS	符号 SYMBOL	测试条件 TEST CONDITION	最小值 MIN	最大值 MAX	单位 UNIT
集电极-基极截止电流 Collector-Base Cutoff Current	I _{CBO}	V _{CB} =800V		100	μA
集电极-发射极截止电流 Collector-Emitter Cutoff Current	I _{CEO}	V _{CE} =450V, I _B =0		250	μA
集电极-基极电压 Collector-Base Voltage	V _{CBO}	I _C =1mA, I _E =0	800		V
集电极-发射极电压 Collector-Emitter Voltage	V _{CEO}	I _C =10mA, I _B =0	450		V
发射极-基极电压 Emitter-Base Voltage	V _{EBO}	I _E =1mA, I _C =0	9		V
集电极-发射极饱和电压 Collector-Emitter Saturation Voltage	V _{cesat}	I _C =1.0A, I _B =0.2A		0.5	V
		I _C =2A, I _B =0.5A		1.0	
发射极-基极饱和电压 Base-Emitter Saturation Voltage	V _{besat}	I _C =1.0A, I _B =0.2A		1.5	V
电流放大倍数 DC Current Gain	h _{FE}	V _{CE} =5V, I _C =10mA	7		
		V _{CE} =5V, I _C =1.0A	10	40	
		V _{CE} =5V, I _C =4A	5		
贮存时间/Storage Time	t _s	V _{CC} =5V, I _C =0.5A, (UI9600)	2.0	4.0	μs
下降时间/Falling Time	t _f			0.8	
内置二极管正向压降 Diode Forward Voltage	V _F	I _F =2A		1.7	V

●订单信息/ORDERING INFORMATION:

包装形式/PACKING	订货编码/ORDERING CODE	
	普通塑封料/ Normal Package Material	无卤塑封料/Halogen Free
TO-220 普通袋装/NORMAL PACKING	MJE13005H TO-220	MJE13005H TO-220-HF
TO-220 条管装/TUBE PACKING	MJE13005H TO-220-TU	MJE13005H TO-220-TU-HF
TO-220FP 普通袋装/NORMAL PACKING	MJE13005H TO-220FP	MJE13005H TO-220FP-HF
TO-220FP 条管装/TUBE PACKING	MJE13005H TO-220FP-TU	MJE13005H TO-220FP-TU-HF

NPN D 系列晶体管 / D SERIES TRANSISTORS

MJE13005H

SOA (DC)

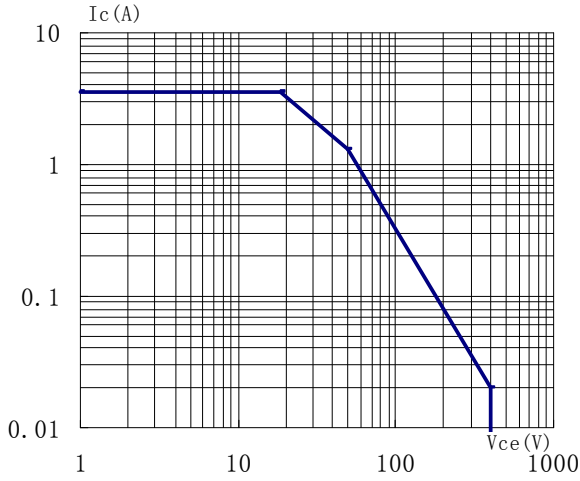

$P_{tot} \propto T_j$

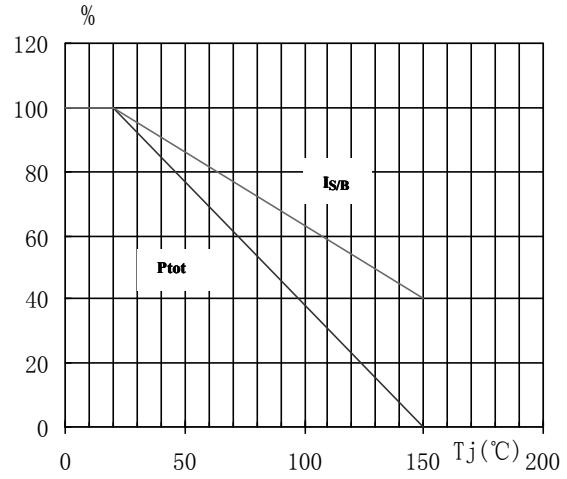

$h_{FE} - I_c$

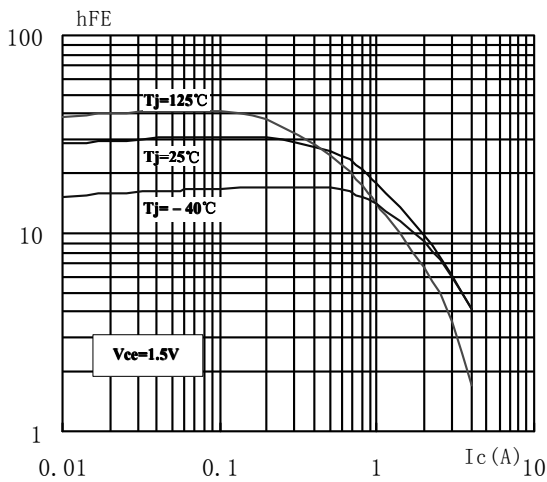

$h_{FE} - I_c$

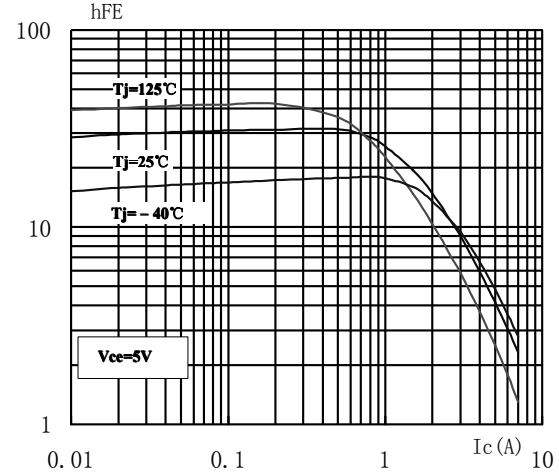

$V_{cesat} - I_c$

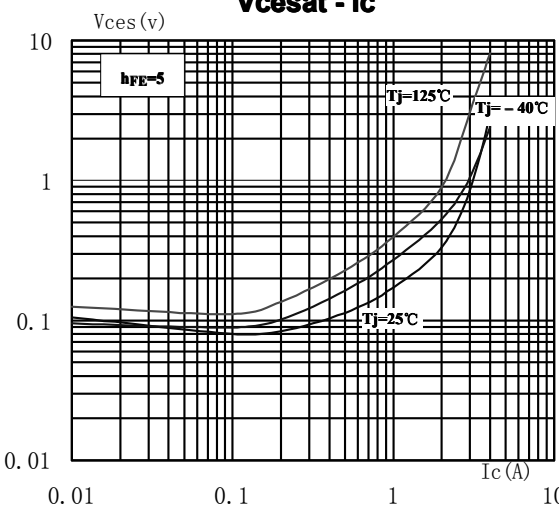

$V_{besat} - I_c$

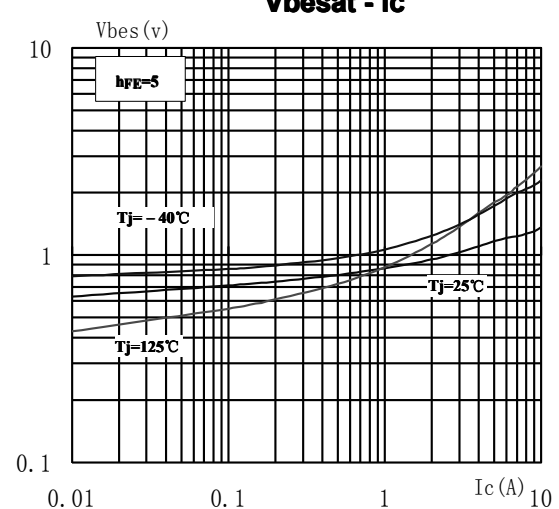

TO-220 封装机械尺寸 TO-220 MECHANICAL DATA

单位：毫米/UNIT: mm

符号 SYMBOL	最小值 min	典型值 nom	最大值 max	符号 SYMBOL	最小值 min	典型值 nom	最大值 max
A	4.00		4.80	E	9.90		10.70
B	1.20		1.50	e		2.54	
B1	1.00		1.40	F	1.10		1.45
b1	0.65		1.00	L	12.50		14.50
c	0.35		0.75	L1	3.00	3.50	4.00
D	15.00		16.50	Q	2.50		3.00
D1	5.90		6.90	Q1	2.00		3.00
				φP	3.60		3.90

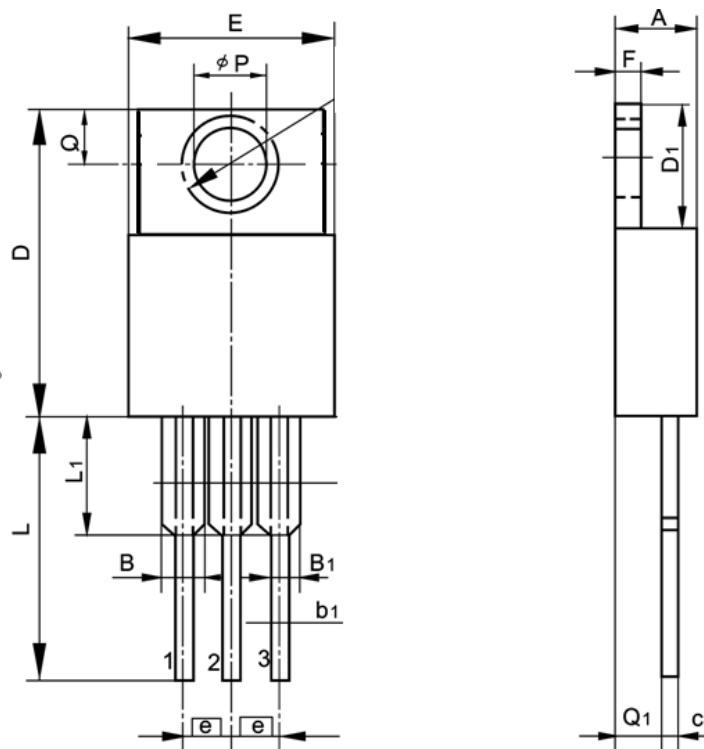

TO-220FP 封装机械尺寸 TO-220FP MECHANICAL DATA

单位:毫米/UNIT: mm

符号 SYMBOL	最小值 min	典型值 nom	最大值 max	符号 SYMBOL	最小值 min	典型值 nom	最大值 max
A	4.40		4.95	e		2.54	
A ₁	2.30		2.90	L	12.50		14.30
b	0.45		0.90	L ₁	9.10		10.05
b ₁	1.10		1.70	L ₂	15.00		16.00
c	0.35		0.90	L ₃	3.00		4.00
D	14.50		17.00	øp	3.00		3.50
D ₁	6.10		9.00	Q	2.30		2.80
E	9.60		10.30				

